

SPS 4-50 (8895011)

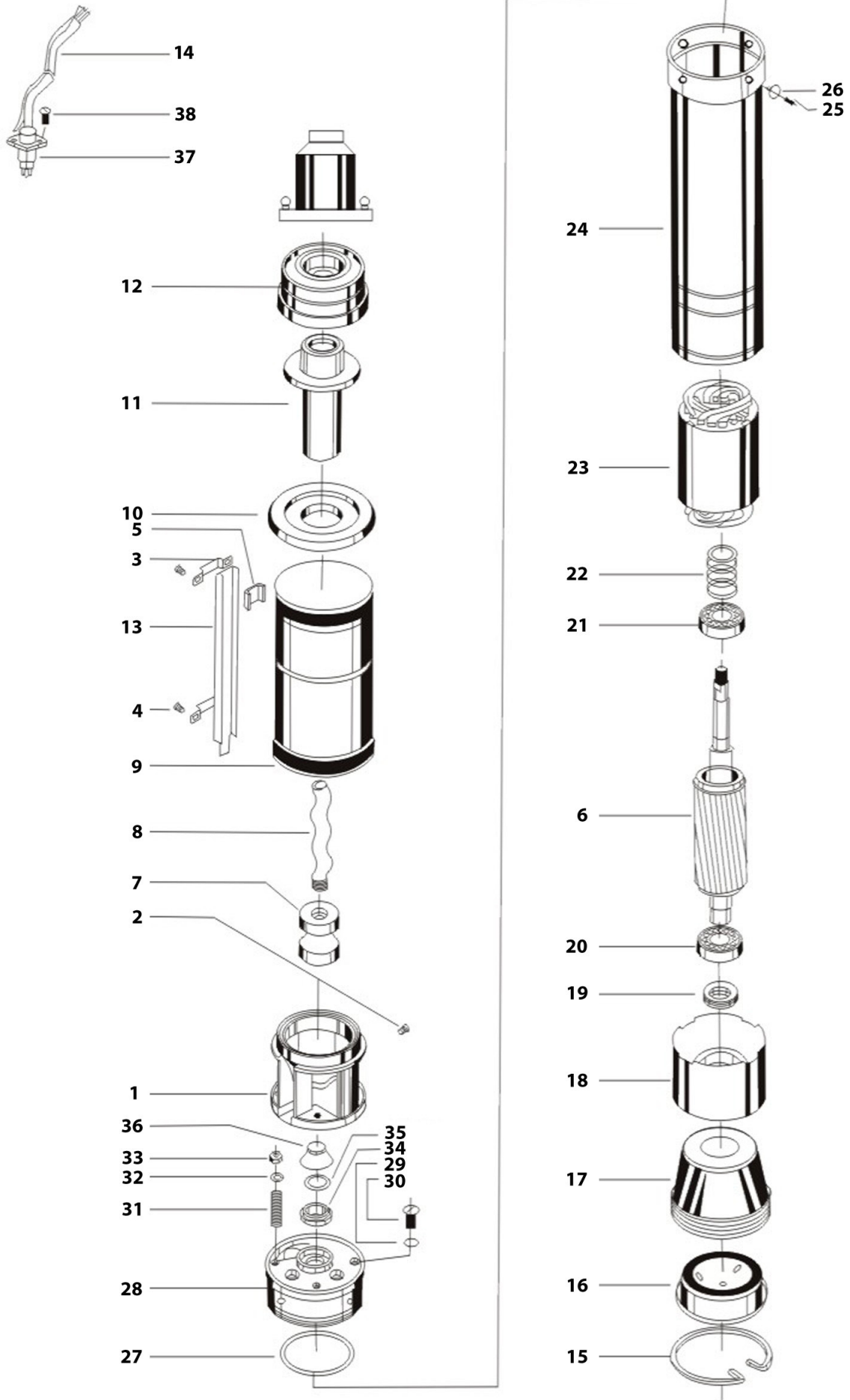

position	description	popis	QTY	order no./ objednací číslo
1	Suction support	podstavec sání	1	
2	Screw	šroub	1	
3	Holder clip	svorka	1	
4	Screw	šroub	1	
5	Cable shield	kryt kabelu	1	
6	Motor rotor	rotor motoru	1	
7	Coupling	propojka	1	8895011A
8	Rotor	rotor	1	8895011A
9	Pump pipe	tubus pumpy	1	
10	Flange	příruba	1	
11	Stator	stator	1	8895011A
12	Cheek valve	ložisko	1	
13	Cable cover	kryt kabelu	1	
14	Cable	přívodní kabel	1	
15	Clamping spring	upínací pružina	1	
16	End cover	spodní kryt	1	
17	Rubber cup	gumový podstavec	1	
18	Bearing seat	spodní kryt motoru	1	
19	Thrust bearing	sedlo ložiska	1	
20	Deep groove ball bearings	kuličkové ložisko	1	
21	Deep aroove ball bearings	kuličkové ložisko	1	
22	Mechanical seal	mechanická ucpávka	1	8895011B
23	Motor stator	stator motoru	1	
24	Motor pipe	tubus motoru	1	
25	Screw	šroub	1	
26	Locking ring	pojistný kroužek	1	
27	"O" ring	O kroužek	1	8895011-27
28	Oil chamber	olejová nádrž	1	
29	"O"ring	O kroužek	1	
30	Screw	šroub	1	
31	Stud	šroub	1	
32	Washer	podložka	1	
33	Nut	matice	1	
34	Static ring	podložka	1	8895011B
35	Gasket	těsnění	1	8895011B
36	Sand proof cap	ochraný kryt proti písku	1	
37	Cable shield sleeve	průchodka kabelu	1	
38	Screw	šroub	1	
	capacitor	kondenzátor	1	8895011C
	Termal fuse	tepelná pojistka	1	8895011P